



communications
OPERATING and SERVICE
INSTRUCTIONS

S-119

the hallicrafters co.
MANUFACTURERS OF ELECTRONIC EQUIPMENT, CHICAGO 24, U. S. A.

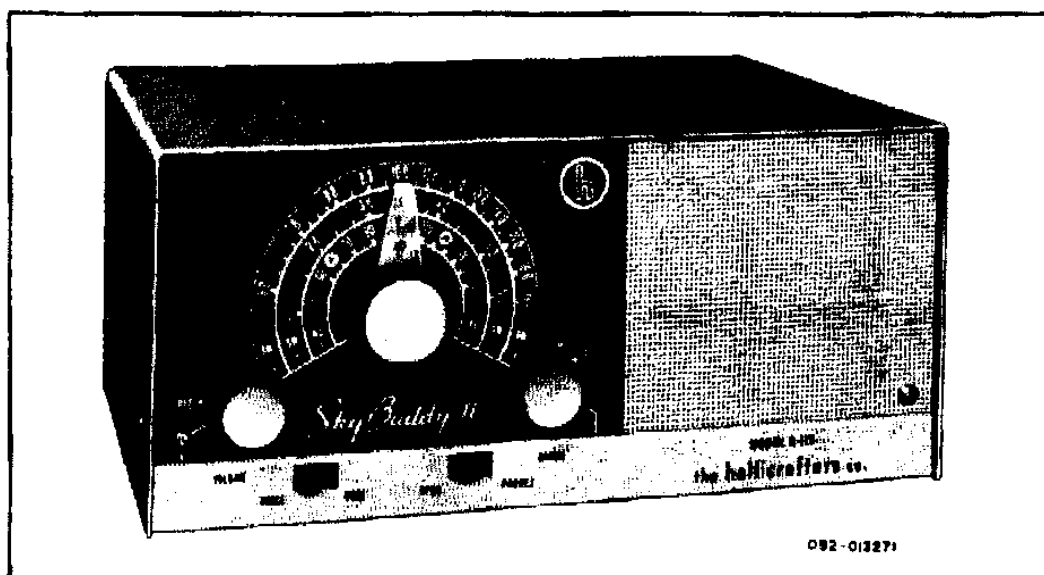

Figure 1. View of Receiver.

TECHNICAL SPECIFICATIONS

RECEPTION	AM and CW.
FREQUENCY COVERAGE	Three bands.
Band 1	535 KC to 1640 KC.
Band 2	2.0 MC to 5.5 MC.
Band 3	5.7 MC to 16.4 MC.
INTERMEDIATE FREQUENCY	455 KC.
POWER SOURCE	105 volts to 125 volts AC, 60 cycles.
POWER CONSUMPTION	16 watts.
NUMBER OF TUBES	Three tubes plus one selenium rectifier.
SPEAKER OUTPUT	Internal speaker provided. Slide switch on front panel and pin-type socket connector on rear panel are provided for external use of headphones or earplug.
ANTENNA INPUT	Ferrite rod provided for use with standard broadcast band; two-contact, screw-type terminal strip provided on chassis rear for connecting short-wave antenna.
DIMENSIONS	10-1/2 inches wide, 7-1/2 inches deep, and 5 inches high.
SHIPPING WEIGHT	9 pounds.
NET WEIGHT	7.5 pounds approximately.

SECTION I GENERAL DESCRIPTION

1-1. INTRODUCTION.

Your new Hallicrafters *Sky Buddy II* * Receiver Model S-119 or S-119K has been designed to bring you the finest in low cost, economical, world-wide radio reception. The receiver covers the frequency range from 535 kilocycles to 16.4 megacycles in three bands ... 535 kilocycles to 1.64 megacycles, 2.0 megacycles to 5.5 megacycles, and 5.7 megacycles to 16.4 megacycles. You will hear foreign and domestic short-wave broadcasts, amateurs, police, aircraft, ships, and countless other exciting, distant stations ... as well as all your favorite programs on standard broadcast. The receiver employs the latest type superheterodyne circuit and provides for reception of AM (voice) and CW (code) signals over its entire tuning range.

Special features built into the Model S-119 Receiver include ... a high sensitivity ferrite rod antenna for broadcast-band reception ... a powerful Alnico V permanent magnet type speaker ... provisions for headphone operation ... identification of the civil defense emergency frequencies. Correct time may be checked against the time standard at station WWV on four different frequencies.

SECTION II INSTALLATION

2-1. UNPACKING.

After unpacking the receiver, examine it carefully for damage which may have occurred in transit. Should any sign of damage be apparent, file a claim immediately with the carrier stating the extent of damage. Check all shipping tags and labels for instructions before removing or destroying them.

2-2. LOCATION.

The receiver is equipped with rubber mounting feet for table or shelf mounting. When locating the receiver, avoid excessively warm locations such as those near radiators and heating vents. Allow at least one inch of clearance between the back of the receiver and the wall for proper ventilation.

2-3. POWER SOURCE.

The Model S-119 Receiver is designed to operate from a 105-volt to 125-volt, 60-cycle AC power source. Power consumption is 16 watts.

NOTE

If in doubt about your power source, contact your local power company prior to inserting the power cord into an AC power outlet. Connecting the receiver to the wrong power source may cause extensive damage to the unit and costly repairs.

2-4. ANTENNAS.

A ferrite rod is mounted on the back cover of the receiver for use when listening to the standard broadcast band. In some localities, a slight turn of the

* Copyright property of The Hallicrafters Company. Patent Application pending.

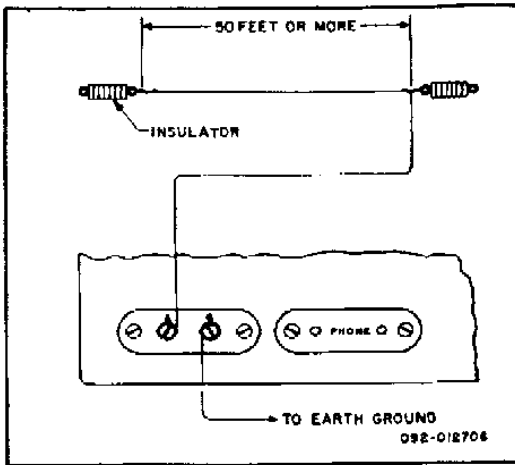

Figure 2. Single Wire Antenna.

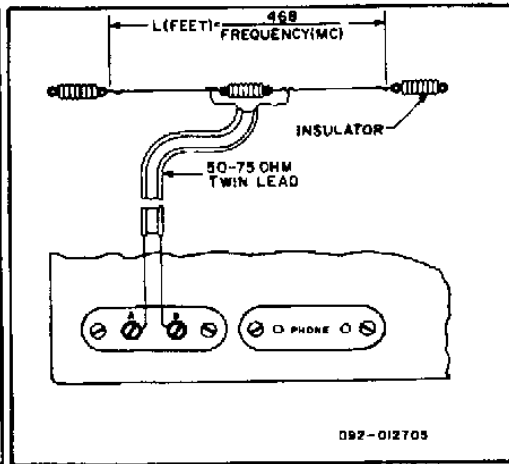

Figure 3. Doublet Antenna.

receiver may improve broadcast-band reception. To receive weak and distant signals, it may be desirable to install an external single-wire antenna (see figure 2). When using the single-wire antenna, a ground lead should be connected from terminal G to a cold water pipe or other earth ground.

For top performance on the short-wave bands, the use of a half-wave doublet or other type of tuned antenna is recommended (see figure 3). The doublet antenna should be cut to the proper length for the most used frequency or band of frequencies. The correct length of the antenna may be determined by using the formula contained in figure 3.

For maximum signal pick-up, the doublet antenna should be erected with its length at right angles to the desired station. When using outside antennas, the receiver should have a lightning arrestor in the antenna lead-in as a protection against lightning.

2-5. HEADPHONES.

A two-connector terminal strip, marked PHONES, is located on the rear panel of the receiver for using headphones. Any commercial, pin-type headphones or ear-plugs may be used as no direct current flows in the headphone circuit. For maximum headphone output, the use of low-impedance magnetic phones (50 ohms to 1000 ohms) is recommended.

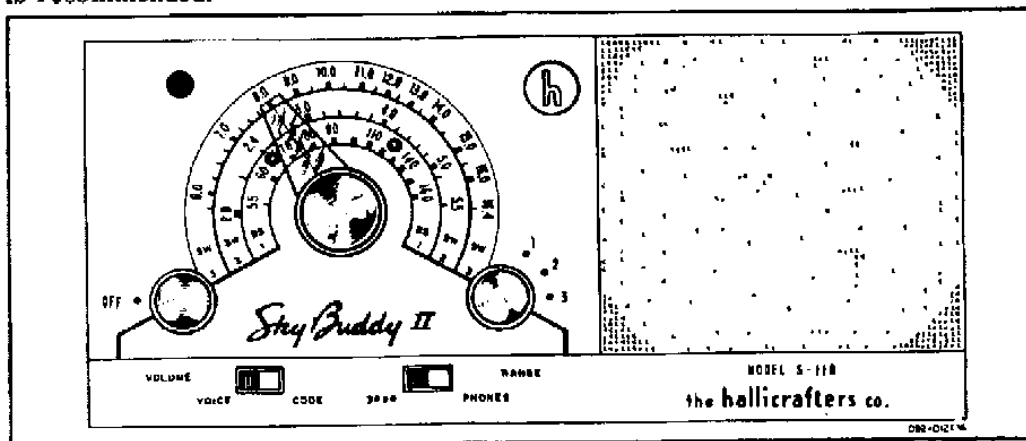

Figure 4. Front Panel View of Receiver.

SECTION III

OPERATING CONTROLS

3-1. GENERAL.

Each control of the receiver performs a definite function which contributes to its reception capabilities. Full appreciation of the receiver is to be expected only after becoming familiar with each of the controls and the effect each control has on the performance of the receiver. A brief description of each control is contained in the following paragraphs (see figure 4).

3-2. VOLUME CONTROL.

The VOLUME control, the left-hand knob on the front panel, is used to turn the receiver ON and OFF and to adjust the audio signal level to the most pleasing volume. Clockwise rotation of this knob turns the receiver ON and increases volume; counterclockwise rotation decreases volume and turns the receiver OFF.

3-3. RANGE SWITCH.

The RANGE switch, the right-hand knob on the front panel, selects the band of frequencies to be listened to ... position 1 for standard broadcast reception and positions 2 or 3 for short-wave reception depending upon which frequency range is desired.

3-4. TUNING CONTROL.

The TUNING control drives a pointer to indicate what station is being heard. The inner dial scale (band 1) is the standard broadcast band. To convert the readings on this band to kilocycles, add one zero (i.e., 70 on the dial is 700 kilocycles). The two outer dial scales (bands 2 and 3) are the short-wave bands. The readings on these bands are directly in megacycles (i.e., 1.6 on the dial is 1.6 megacycles). The standard broadcast band is marked with a CD emblem (a triangle in a circle) at 640 KC and at 1240 KC to indicate the two official civil defense frequencies. In a civil defense emergency, tune to either of these two frequencies for official news, instructions, and information.

3-5. VOICE-CODE SWITCH.

The VOICE-CODE switch is a two-position slide switch. Its primary function is to provide the necessary beat frequency tone when receiving CW (code) signals. In the left-hand position, this switch permits the reception of voice signals; in the right-hand position, CW signals may be received.

3-6. SPKR-PHONES SWITCH.

The SPKR-PHONES switch is a two-position slide switch. In the left-hand (SPKR) position, the speaker within the receiver is connected into the circuit. Switching to the right-hand (PHONES) position allows the use of external headphones or earplugs which may be plugged into the Phones connector on the rear panel.

SECTION IV

OPERATION

4-1. PROCEDURE.

1. Turn VOLUME control approximately one-half turn clockwise.
2. Set RANGE switch to the desired band.
3. Rotate the TUNING control to the desired station and tune for the clearest tone.
4. Readjust the VOLUME control to a pleasing level.

4-2. NOTES.

1. If voices or music sound garbled, check to make sure that the VOICE-CODE switch is in the VOICE position.
2. An external antenna should be connected (see paragraph 2-4) if the receiver is being operated on either short-wave band.
3. If no sound is heard after the receiver has been on for five minutes or more, check to make sure that the SPKR-PHONES switch is in the SPKR position. (If headphones or earplugs are used, this switch should be in the PHONES position.)
4. Correct time may be checked against station WWV on four different frequencies: 2.5 MC, 5.0 MC, 10.0 MC, and 15.0 MC. The VOICE-CODE switch should be in the VOICE position when performing a time check.

4-3. SERVICE AND OPERATING QUESTIONS.

For further information regarding operation or servicing of the receiver, contact The Hallicrafters dealer from whom the receiver was purchased. The Hallicrafters Company maintains an extensive system of authorized service centers where any required service will be performed promptly and efficiently at a nominal charge. All Hallicrafters Authorized Service Centers display the sign shown below. For the location of the one nearest you, consult your dealer or telephone directory.

Do not make any service shipments to the factory unless instructed to do so by letter. The Hallicrafters Company will not accept the responsibility for any unauthorized shipments.

The Hallicrafters Company reserves the privilege of making revisions in current production of equipment and assumes no obligation to incorporate these revisions in earlier models.



SECTION V SERVICE DATA

5-1. TUBE AND DIAL LAMP REPLACEMENT.

To gain access to the tubes and dial lamps, refer to paragraph 5-2, CABINET REMOVAL. The tube locations are shown in figures 5 and 6.

5-2. CABINET REMOVAL.

The cabinet of the Model S-119 Receiver is divided into two pieces. The top and sides of the cabinet may be removed by removing the two screws on each side of the receiver. To gain access to the components located under the chassis, remove the four screws on the bottom, one in each foot.

5-3. VOLTAGE MEASUREMENTS.

The voltages on the pins of each tube within the Model S-119 Receiver are listed in the Voltage Chart below. Voltages were measured with the VOLUME control at minimum (counterclockwise), RANGE switch on Band 3, VOICE-CODE switch on VOICE, and SPKR-PHONES switch on SPKR. All voltages measured to chassis.

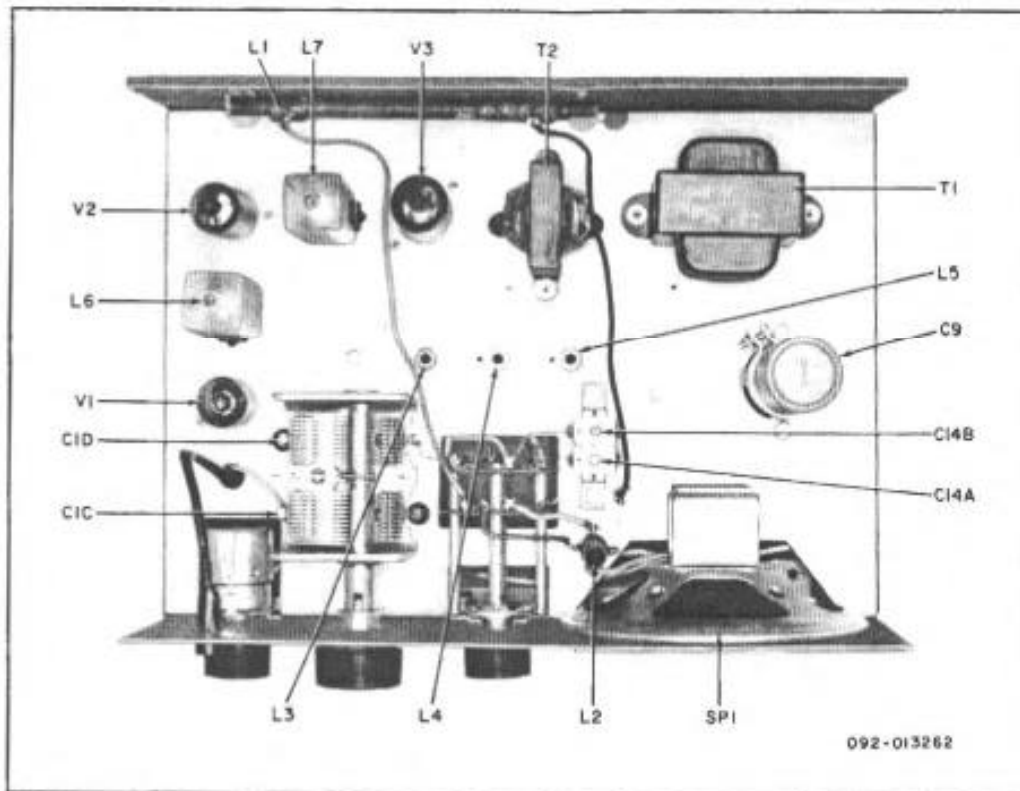

Figure 5. Top Chassis View of Receiver.

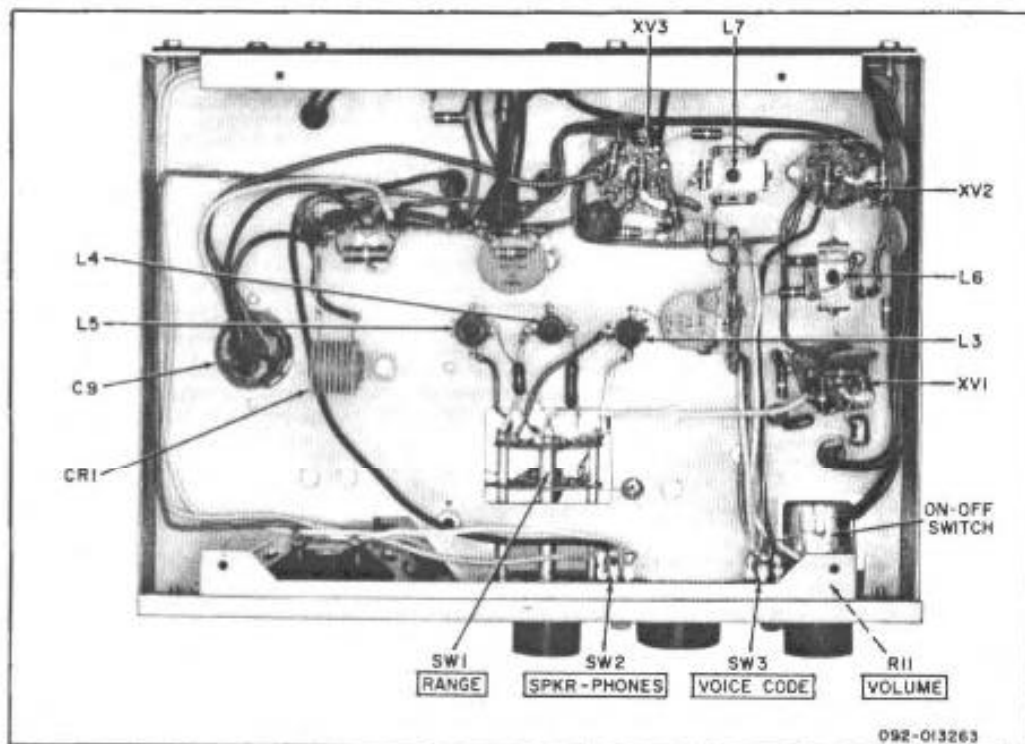

Figure 6. Bottom Chassis View of Receiver.

VOLTAGE CHART

V1, 6BE6		V2, 6BA6		V3, 6CM8	
Pin	Voltage	Pin	Voltage	Pin	Voltage
1	-6.2V DC	1	-0.07V DC	1	+83V DC
2	0 V	2	0 V	2	0 V
3	0 V	3	8.3V AC	3	+1.4V DC
4	6.3V AC	4	0 V	4	6.3V AC
5	+105V DC	5	+86V DC	5	0 V
6	+105V DC	6	+66V DC	6	+136V DC
7	-0.13V DC*	7	+1.65V DC*	7	+103V DC
* Change with frequency setting.				8	0 V
				9	-1.85V DC

SECTION VI

ALIGNMENT S-119

(WIRED RECEIVERS)

6-1. GENERAL.

This receiver has been carefully aligned at the factory by specially trained personnel using precision equipment. Alignment of the receiver should not be attempted until all other possible causes of faulty operation have been investigated. Alignment should not be required unless the receiver has been tampered with or component parts have been replaced in the RF or IF stages. Alignment should only be made by persons familiar with and experienced in receiver alignment. Refer to figures 5 and 6 for the location of all alignment adjustments.

6-2. EQUIPMENT REQUIRED.

1. A signal generator covering the frequency range from 455 KC to 16.5 MC.
2. An output meter (or AC scale of a VTVM). Connect the meter across the pins on the Phones connector strip on the chassis rear.
3. A non-metallic alignment tool.
4. A 47-ohm resistor.

6-3. INITIAL CONTROL SETTINGS.

1. Set RANGE switch to Band 3.
2. Set TUNING control to mid-range.
3. Set SPKR-PHONES switch to PHONES.
4. Set VOICE-CODE switch to VOICE.
5. Maintain the VOLUME at the minimum necessary to obtain half-scale reading on the output meter.

6-4. ALIGNMENT PROCEDURE.

NOTE

Throughout the alignment the signal generator output should be adjusted to maintain a reading on the output meter less than audio overload.

INTERMEDIATE FREQUENCY (455 KC)

1. Connect the signal generator to the stator plates of the front section of the tuning gang. Set the signal generator to 455 KC modulated 30% at 1000 CPS.
2. Adjust L7 secondary and primary and L6 secondary and primary respectively for maximum indication on the meter. Repeat adjustment to insure accuracy.

BROADCAST BAND (BAND 1: 535 KC to 1640 KC)

1. Connect the signal generator to a standard radiating loop. (A wire connected to the signal generator and placed in close proximity to the receiver chassis is sufficient.)
2. Set the RANGE switch to Band 1 and fully close the main tuning gang.
3. Set the frequency of the signal generator to 535 KC.
4. Adjust L5 for maximum indication on the output meter.
5. Fully open the main tuning gang and set the signal generator frequency to 1640 KC.
6. Adjust C1D for maximum indication on the output meter.
7. Set the signal generator frequency to 1400 KC and tune the receiver to this frequency.
8. Adjust C1C for maximum indication on the output meter.

NOTE

For correct adjustment of the trimmers in the broadcast band, the cabinet cover must be placed over the receiver. This may be accomplished by inverting the cover and placing it over the chassis by resting it on the front and back panel. Leave sufficient room to adjust the trimmers.

BAND 2 (2 MC to 5.5 MC)

1. Set the RANGE switch to Band 2.
2. Connect the signal generator to the antenna connector strip on the rear of the receiver. Connect the high side of the signal generator to the terminal marked A through a 47-ohm resistor and the low side to the terminal marked G.
3. Set the signal generator frequency to 2.0 MC and fully close the main tuning gang.
4. Adjust L4 for maximum indication on the output meter.

5. Set the signal generator frequency to 5.5 MC and fully open the main tuning gang.
6. Adjust C14B for maximum indication on the output meter.
7. Set the signal generator frequency and the receiver frequency to 2.5 MC.
8. Adjust L2 for maximum indication on the output meter. L2 has two peaks. The correct adjustment is the second peak from the bottom of the coil.

BAND 3 (5.7 MC to 16.4 MC)

1. Set the RANGE switch to Band 3.
2. Set the signal generator frequency to 5.7 MC and fully close the main tuning gang.
3. Adjust L3 for maximum indication on the output meter.
4. Set the signal generator frequency and the receiver frequency to 15 MC.
5. Adjust C14A for maximum indication on the output meter.

SECTION VII ADJUSTMENT S-119K (KIT RECEIVERS)

7-1. GENERAL.

The receiver kit has been carefully engineered at the factory for optimum performance. To obtain this performance from your receiver it will require alignment by experienced personnel equipped with proper test equipment.

A method of preliminary adjustment of your receiver using the calibration and harmonics of your standard AM broadcast receiver's local oscillator is included in this section. To obtain the full capabilities of your receiver we recommend you have your local radio and TV service man align the receiver for you upon completion of the wiring and preliminary adjustments.

The completed receiver may be returned to The Hallicrafters Company for alignment should you prefer, where it will be aligned and tested for a nominal charge of \$5.00. If additional repairs are required, the regular service charge and handling described in the service policy covering this model will be applicable. When returning the receiver to The Hallicrafters Company, allow 3 to 4 weeks for handling.

7-2. EQUIPMENT REQUIRED.

1. Small screwdriver with an insulated handle.
2. Standard AM broadcast receiver.

7-3. INITIAL CONTROL SETTINGS.

1. Set RANGE switch to Band 1.
2. Set SPKR-PHONES switch to SPKR.
3. Set VOICE-CODE switch to VOICE.
4. Turn set on and set the VOLUME control to mid-range.
5. Tune your standard broadcast receiver to a local broadcast station between 1550 KC and 1640 KC.

6. Set the TUNING control dial of your S-119K Receiver to the same dial reading as your standard broadcast receiver which is tuned to a local station between 1550 KC and 1640 KC.
7. Throughout the adjustments, maintain the volume level at a minimum.
8. All coils are factory set. Do not attempt adjustment of any coil. Refer to alignment procedure for correct alignment of all coils.
9. For correct adjustment, the cabinet cover must be placed over the receiver. This may be accomplished by inverting the cover and placing it over the chassis by resting it on the front and rear panels. Leave sufficient room to adjust the trimmers which are mounted on the left side of the main tuning capacitor C1.

7-4. ADJUSTMENT PROCEDURE.

Broadcast Band (Band 1: 535 KC to 1840 KC)

1. Adjust C1D until the S-119K Receiver is receiving the same station as your standard broadcast receiver. This trimmer should be adjusted for the maximum volume level of this station when the S-119K dial indicator is on the same dial reading as your standard broadcast receiver.
2. Set your standard broadcast receiver to a local radio station between 1350 KC and 1450 KC.
3. Tune the same station in on your S-119K receiver and adjust C1C for the maximum volume level.

Band 2 (2 MC to 5.5 MC)

1. Set the RANGE switch to Band 2.
2. Set the VOICE-CODE switch to CODE.
3. Connect a short length of insulated wire to antenna terminal "A" at the rear of the receiver. Wrap several turns of the free end of this wire around the cabinet of your standard broadcast receiver.
4. Set your standard broadcast receiver to 1300 KC.
5. Set the TUNING control dial of your S-119K to 5.25 MC.
6. Adjust C14B until a continuous whistle is heard.
NOTE: Tune your standard broadcast receiver slightly off 1300 KC. If the whistle varies as you tune your standard broadcast receiver, you are correctly adjusted. Should the whistle remain, retune your standard broadcast receiver to 1300 KC and readjust C14B to the next whistle signal and recheck. Continue this procedure until the correct whistle signal is found. This will be the loudest whistle signal which varies when you tune your standard broadcast receiver. Adjust this signal for the maximum volume level.

Band 3 (5.7 MC to 18.4 MC)

1. Set the RANGE switch to Band 3.
2. Set the VOICE-CODE switch to VOICE.
3. Remove the short length of wire connected to your antenna terminals and connect your antenna to these terminals.
4. Turn off your standard broadcast receiver.
5. Tune in a voice station on Band 3 between 15 MC and 16.4 MC.
6. Adjust C14A for the maximum volume level on this station.

This completes the preliminary adjustments of your S-119K Receiver.

SERVICE REPAIR PARTS LIST

<u>Schematic Symbol</u>	<u>Description</u>	<u>Hallcrafters Part Number</u>
CAPACITORS		
C1A,B,C,D	Variable, TUNING	048-003542
C2,15	100 mmf, 10%, 300V, Duramica	481-183101
C3,4,5	0.02 mfd, +80%, -20%, 600V, Ceramic Disc	047-100242
C8,7,17	470 mmf, 10%, 500V, Ceramic Disc	047-200643
C8,11	0.002 mfd, 20%, 600V, Ceramic Disc	047-100395
C9A,B,C	60 mfd, 175V; 60 mfd, 150V; 20 mfd, 25V; Electrolytic	045-000813
C10	0.005 mfd, 800V, GMV, Ceramic Disc	047-100188
C12	1500 mmf, 2%, 300V, Duramica	481-281152
C13	430 mmf, 2%, 300V, Duramica	481-181431
C14A,B	Variable, Trimmer Assembly	044-000553
C18	0.01 mfd, 1400V, Type U, Ceramic Disc	047-200752
C18	0.01 mfd, 800V, GMV, Ceramic Disc	047-100224

RESISTORS*

R1,12	1 Megohm	451-252105
R2,7	1K Ohm	451-252102
R3	22K Ohm	451-252223
R4,8	2.2 Megohm	451-252225
R5	470 Ohm	451-252471
R8,13	180 Ohm	451-252181
R9	2.2K Ohm	451-252222
R10	47K Ohm	451-252473
R11	1 Megohm, Variable (VOLUME)	025-002054
R14,18	470K Ohm	451-252474
R15	58K Ohm	451-252563
R18	82 Ohm	451-252820
R17	1.8K Ohm, 1W	451-352182

* All RESISTORS, 1/2 watt, 10%, carbon type unless otherwise stated.

COILS

L1	Antenna Loopstick (Band 1)	057-000400
L2	Antenna (Bands 2 and 3)	051-003328-02
L3	Oscillator (Band 3)	051-003331-02
L4	Oscillator (Band 2)	051-003330-02
L5	Oscillator (Band 1)	051-003329-02
L6	1st IF	050-000778
L7	2nd IF	050-000779

SWITCHES

SW1A&B	Rotary (RANGE)	080-002427
SW2,3	Slide, SPDT (VOICE-CODE, SPKR-PHONES)	060-002428

KNOBS

Tuning	015-001888
Range, Volume	015-001889

SERVICE REPAIR PARTS LIST (CONT.)

<u>Schematic Symbol</u>	<u>Description</u>	<u>Hallicrafters Part Number</u>
TRANSFORMERS		
T1	Power	052-000935
T2	Audio Output	055-000465
TUBES		
V1	6BE6	090-901124
V2	6BA6	090-901112
V3	6CM6	090-901471
DIODES		
CR1	Rectifier, Selenium	027-000290
CR2	1N295	019-301980
SOCKETS		
XV1, 2	7 Pin, Miniature	006-000308
XV3	9 Pin, Miniature	006-000907
MISCELLANEOUS		
	Clamp, Electrolytic Mtg.	076-003806
	Clip, IF Mounting	076-003779
	Cover, Cabinet	066-003320
	Dial Indicator	062-000559
	Foot, Mounting	016-002186
	Front Panel Assembly	150-003544
LM1	Lamp, Indicator	066-000597
PL1	Line Cord	067-100078
	Lock, Line Cord	076-000974
	Panel, Bottom	068-001246
	Rear Panel Rivet Assembly	150-003543
SP1	Speaker, 8-Ohm	085-000217
TA1	Terminal Board (A-G)	066-202026
TA2	Terminal Board (Phones)	088-100071

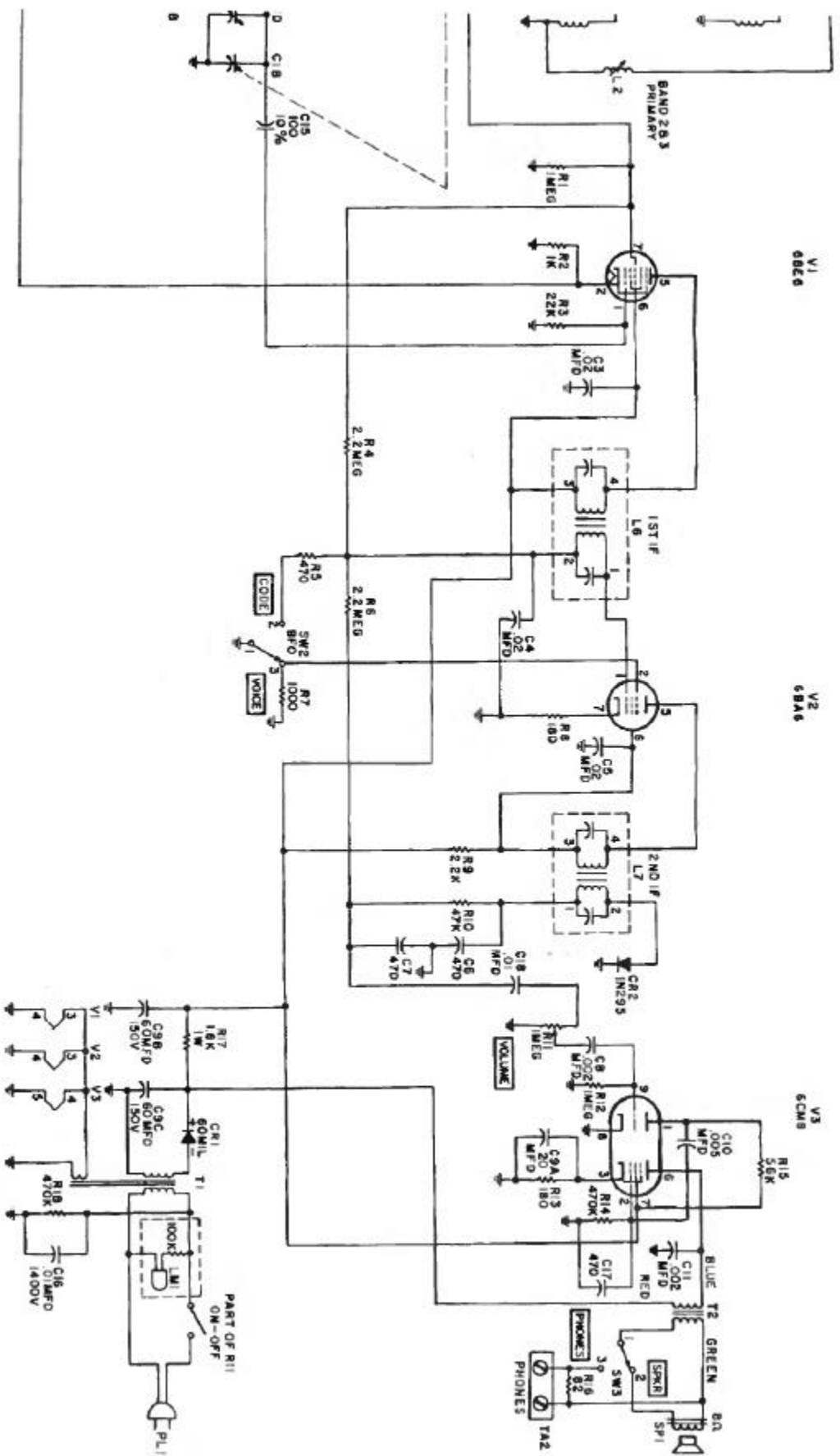

Figure 7. Schematic Diagram.

